



CONSTRUCTION ATTACHMENTS, INC.

PROUDLY MADE IN THE USA

PRODUCT GUIDE ATTACHMENT AND APPLICATION SELECTION



1160 CAL COURT, LENOIR, NORTH CAROLINA 28645 USA

www.constructionattachments.com

sales@calmfg.com | ph (828) 758-2674 | fax (828) 754-1887



HYDRAULIC BREAKERS



DESIGNED FOR AIDING IN CONSTRUCTION AND DEMOLITION OF CONCRETE STRUCTURES, ROCKS, ASPHALT, ETC.

FOR COMPACT EXCAVATORS, TRACTOR LOADER BACKHOES AND MID/LARGE EXCAVATORS

PRODUCT FEATURES:

- More power, more impact energy per dollar than any hammer on the market
- Designed with fewer parts to insure quicker and less costly maintenance
- Excavator models come complete with mounting bracket, hoses and 1 point of choice.
(additional charge for tamping pad and asphalt cutter)

WARNING: Chisel paste must be used with hydraulic breakers. Using high temperature grease as a substitution for chisel paste will cause damage to components of breaker.



Item #	Description	Operating Pressure PSI	Oil Flow Required GPM	Machine Weight Class lbs	Tool Dia.	Hose Diameter & Length	Est Weight lbs
1BR225D-EX	CAL 225D Hydraulic Breaker	1,305-1,740	3.76-6.6	1,400-3,000	1.77"	1/2"x80"	294
1BR500D-EX	CAL 500D Hydraulic Breaker	1,280-1,710	7.0-16.0	3,000-8,000	2.24"	1/2"x80"	406
1BR650D-EX	CAL 650D Hydraulic Breaker	1,565-2,347	9.25-18.49	5,000-9,000	2.76"	3/4"x80"	546
1BR850D-EX	CAL 850D Hydraulic Breaker	1,740-2,393	10.57-22.1	5,000-11,000	2.95"	3/4"x80"	836
1BR1000D-EX	CAL 1000D Hydraulic Breaker	2,030-2,465	14.6-24.8	7,000-15,000	3.15"	3/4"x80"	1020
1BR1200D-EX	CAL 1200D Hydraulic Breaker	2,030-2,465	15.9-26.4	10,000-20,000	3.54"	3/4"x80"	1220
1BR2200D-EX	CAL 2200D Hydraulic Breaker	2,030-2,610	23.8-37.1	20,000-32,000	4.14"	3/4"x80"	2186

Models 225D-2200D are available with a quick coupler or pin-on hitch. Specify make and model of host machine when ordering. Weights may vary based on selected hitch styles.

* Product design subject to change

HYDRAULIC BREAKERS



DESIGNED FOR AIDING IN CONSTRUCTION AND DEMOLITION OF CONCRETE STRUCTURES, ROCKS, ASPHALT, ETC.

FOR COMPACT EXCAVATORS, TRACTOR LOADER BACKHOES AND MID/LARGE EXCAVATORS (CONT'D)

WARNING: Chisel paste must be used with hydraulic breakers. Using high temperature grease as a substitution for chisel paste will cause damage to components of breaker.

Item #	Description	Operating Pressure PSI	Oil Flow Required GPM	Machine Weight Class lbs	Tool Dia.	Hose Diameter & Length	Est Weight lbs
1BR2200D-EX	CAL 2200D Hydraulic Breaker	3,030-2,610	23.8-37.1	20,000-32,000	4.14"	3/4"x80"	2186
1BR3200D-EX	CAL 3200D Hydraulic Breaker	2,320-2,750	34.4-68.7	32,000-44,000	4.92"	1"x90"	3490
1BR4500D-EX	CAL 4500D Hydraulic Breaker	2,320-2,750	34.4-68.7	36,000-56,000	5.32"	1"x90"	4294
1BR6000D-EX	CAL 6000D Hydraulic Breaker	2,320-2,750	14.6-73.9	44,000-70,000	5.90"	1-1/4"x108"	5764
1BR8000D-EX	CAL 8000D Hydraulic Breaker	2,320-2,750	47.6-84.5	70,000-90,000	6.10"	1-1/4"x108"	6430
1BR11000D-EX	CAL 11000D Hydraulic Breaker	2,320-2,750	68.7-105.7	88,000-140,000	6.89"	1-5/8"x110"	7810
1BR18000D-EX	CAL 18000D Hydraulic Breaker	2,320-2,750	95.0-119.0	132,000-220,000	8.26"	1-5/8"X110"	15432

AUTO LUBE SYSTEMS



item# 6BPCAUTOLUBE5



item# 6BPCAUTOLUBE6



item# 6BPCAUTOLUBE12

6BPCAUTOLUBE5	Hammer mounted refillable vibratory auto lube	CAL 550 - CAL 2200
6BPCAUTOLUBE6	Hammer mounted large refillable vibratory auto lube	CAL 3200 - CAL 18000
6BPCAUTOLUBE12	Electric adjustable machine mounted 12V auto lube	CAL 1200 - CAL 18000
6BPCAUTOLUBE24	Electric adjustable machine mounted 24V auto lube	CAL-1200 - CAL-18000

Models 3200D - 18000D come standard with pin-on hitches with pins and locking collar. Specify make and model of host machine when ordering. Weights may vary based on selected hitch styles.

* Product design subject to change

HYDRAULIC BREAKERS



DESIGNED FOR AIDING IN CONSTRUCTION AND DEMOLITION OF CONCRETE STRUCTURES, ROCKS, ASPHALT, ETC.

FOR SKID STEER LOADERS

PRODUCT FEATURES:

- More power, more impact energy per dollar than any hammer on the market
- Designed with fewer parts to insure quicker and less costly maintenance
- Skid steer models come complete with skid steer mounting bracket, hoses, flat faced couplers and 1 point of choice.

(additional charge for tamping pad and asphalt cutter)

WARNING: Chisel paste must be used with hydraulic breakers. Using high temperature grease as a substitution for chisel paste will cause damage to components of breaker.



SHOWN WITH BREAKER STAND (SOLD SEPARATELY)

Item #	Description	Operating Pressure PSI	Oil Flow Required GPM	Machine Weight Class lbs	Tool Dia.	Hose Diameter & Length	Est Weight lbs
1BR225D-SS	CAL 225D Hydraulic Breaker	1,305-2,000	3.76-6.6	1,400-3,000	1.77"	1/2"x80"	296
1BR500D-SS	CAL 500D Hydraulic Breaker	1,280-2,500	6.08-16.0	3,000-8,000	2.24"	1/2"x80"	724
1BR650D-SS	CAL 650D Hydraulic Breaker	1,565-3,500	9.25-18.49	5,000-9,000	2.76"	3/4"x120"	846
1BR850D-SS	CAL 850D Hydraulic Breaker	2,000-3,500	10.57-22.1	5,000-11,000	2.95"	3/4"x120"	968
1BR1000D-SS	CAL 1000D Hydraulic Breaker	2,030-3,500	14.6-24.8	7,000-15,000	3.15"	3/4"x120"	1220

Specify make and model of host machine when ordering.

* Product design subject to change

DESIGNED FOR AIDING IN CONSTRUCTION AND DEMOLITION OF CONCRETE STRUCTURES, ROCKS, ASPHALT, ETC.

Hydraulic Breaker Accessories

MOUNTING BRACKETS



Pin-on Excavator

- Available for all Excavator models
- Pins and locking collars come standard



Skid Steer Universal

- Available for all Skid Steer models
- Comes standard on all Skid Steer model breakers



Dual Mounting Bracket

- Available for all Compact Excavator, Backhoe, and Skid Steer models
- Allows for quick change between Compact Excavator, Backhoe, and Skid Steer machines

CHISEL TOOLS FOR HYDRAULIC BREAKERS

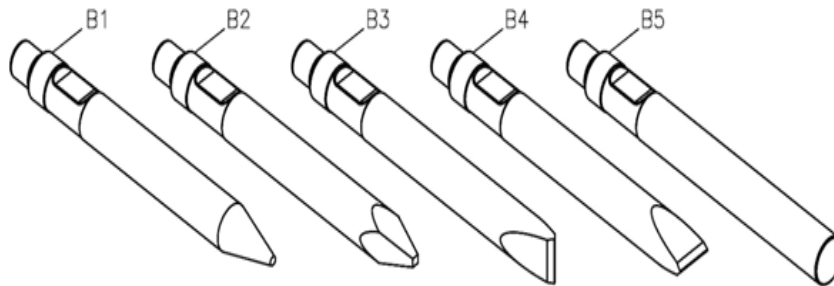

Item	Description	Available Models
B1	Conical Point	All Models
B2	Moil Point	All Models
B3	Cross-Cut Chisel	All Models
B4	In-Line Chisel	All Models
B5	Blunt Point	All Models
B7	Asphalt Cutter	CAL 650 - CAL 1200

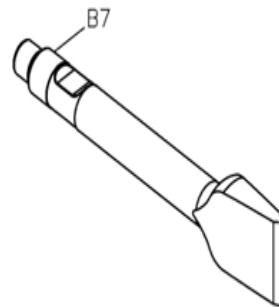

* Product design subject to change

XD HYDRAULIC ROTARY BRUSH CUTTERS



LAND CLEARING MACHINES, POWERFUL, AND VERSATILE ENOUGH TO CUT THROUGH OVERGROWN BRUSH, TREES, AND DENSE TERRAIN

For Skid Steer and Compact Track Loaders

XD BRUSH CUTTER SERIES

	72" Cutter
Overall Cutter Width:	82"
Overall Cutter Depth:	84"
Overall Cutter Height:	25"

- Blade Size: 6" wide x 14.375" Long
- SS Blade Kit (Blade, Bolt, Lock Washer, and Nut (Nuts must be welded))



Powered by:
EATON

Item #		# of Blades	Blade Length	Blade Width	Cutting Capacity Diameter	True Cut Height	Min. Cut Height	Oil Flow Required GMP	Tip Speed FPM	Est Weight (lbs)
1BCSSXD72	72" Skid Steer Standard Flow	3	14-3/8"	6"	4"	72"	2"	16-25 24-45	7,700- 14,600	1200
1BCSSXD72HF	72" Skid Steer High Flow									1230

CAL GRASS ASSASSIN CUTTER SERIES



	72" Cutter
Overall Cutter Width:	79"
Overall Cutter Depth:	78"
Overall Cutter Height:	20"



Item #		# of Blades	Blade Length	Blade Width	Cutting Capacity Diameter	True Cut Width	Min. Cut Height	Oil Flow Required GMP	Tip Speed FPM	Est Weight (lbs)
1BCSSA72	72" Skid Steer Standard Flow	3	24 3/8"	4"	1.5"	72"	1 3/4"	19-45	13,000-23,000	760
1BCSSA72WC	72" Skid Steer With Cooler									780

DO NOT OPERATE ROTARY BRUSH CUTTER WITHOUT A SHATTERPROOF CAB DOOR ON LOADER.

**Specify make and model of host machine when ordering.
Prices and specifications subject to change without notice.**

18 Month Factory Warranty

HYDRAULIC ROTARY BRUSH CUTTERS



LAND CLEARING MACHINES, POWERFUL, AND VERSATILE ENOUGH TO CUT THROUGH OVERGROWN BRUSH, TREES, AND DENSE TERRAIN

For Mini Skid Steer



	42" Cutter	48" Cutter
Overall Cutter Width	50"	56"
Overall Cutter Depth	53"	61"
Overall Cutter Height	22"	

EXCAVATOR CUTTER PRODUCT FEATURES:

- One piece top deck design for strength and structural durability
- 1/2" thick serrated blade carrier
- Recessed carrier design for bolt head protection
- Heavy duty brush guard
- Available with Bobcat MT or Mini Universal Hitch (Dingo)

Item #	Description	# of Blades	Cutting Capacity Diameter	True Cut Width	Min Cut Height	Oil Flow Required GPM	Tip Speed FPM	Est Weight (lbs)
1BCMN42	42" Mini Skid Steer Brush Cutter	2	4"	42"	2.5"	10-18	11,000-18,000	521
1BCMN48	48" Mini Skid Steer Brush Cutter	3		48"				628



- Blade Size: 6" wide x 11.94" long
- Blade Kit (Blade, Bolt, Lock Washer, and Nut (Nuts must be welded))

• 42" Mini Cutter Blade Carrier

• 48" Mini Cutter Blade Carrier

* Product design subject to change

* Product design subject to change

HYDRAULIC ROTARY BRUSH CUTTERS



LAND CLEARING MACHINES, POWERFUL, AND VERSATILE ENOUGH TO CUT THROUGH OVERGROWN BRUSH, TREES, AND DENSE TERRAIN

For Skid Steer and Compact Track Loaders



Powered by:
EATON

	60" Cutter	72" Cutter
Overall Cutter Width	70"	82"
Overall Cutter Depth	77"	84"
Overall Cutter Height	25"	

Item #	Description	# of Blades	Cutting Capacity Diameter	True Cut Width	Min Cut Height	Oil Flow Required GPM	Tip Speed FPM	Est Weight (lbs)
1BCSS60	60" Skid Steer Cutter Standard Flow	3	8"	60"	2"	16-25	7,700-13,600	1626
1BCSS60T	60" Skid Steer Cutter Standard Flow with Teeth							1636
1BCSS72	72" Skid Steer Cutter Standard Flow			1964				
1BCSS72T	72" Skid Steer Cutter Standard Flow with Teeth			1974				
1BCSS72HF	72" Skid Steer Cutter High Flow	3	8"	72"	2"	24-45	7,700-14,600	1994
1BCSS72HFT	72" Skid Steer Cutter HighFlow with Teeth							2004

PRODUCT FEATURES:

- 5/8" thick serrated blade carrier
- 5/8" x 1-1/2" long shank mulching teeth
- 12 teeth per carrier both 60" and 72" models
- Carbide tip cutting surface: 1/2"
- Carbide tip cutting depth: 7/8"
- Wire guard installed for gear box seal protection



- Blade Size: 6" wide x 14.375" Long
- SS Blade Kit (Blade, Bolt, Lock Washer, and Nut (Nuts must be welded))



- Replacement Mulching Teeth

* Product design subject to change

HYDRAULIC ROTARY BRUSH CUTTERS



LAND CLEARING MACHINES, POWERFUL, AND VERSATILE ENOUGH TO CUT THROUGH OVERGROWN BRUSH, TREES, AND DENSE TERRAIN

For Mini / Compact Excavators



	42" Cutter	48" Cutter
Overall Cutter Width	48"	54"
Overall Cutter Depth	48"	54"
Overall Cutter Height	24"	



EXCAVATOR CUTTER PRODUCT FEATURES:

- Wire guard installed on carrier
- 1/2" thick blade carrier
- Integrated deck and hitch with new thumb design
- Recessed carrier design for bolt head protection

Item #	Description	# of Blades	Cutting Capacity Diameter	True Cut Width	Min Cut Height	Oil Flow Required GPM	Tip Speed FPM	Est Weight (lbs)
1BCEX42-41QC	42" Mini EX Brush Cutter 41cc Motor	2	6"	42"	1"	10-18	11,000-18,000	655
1BCEX48-41QC	48" Mini EX Brush Cutter 41cc Motor	3		48"				728

1BCEX42-63QC	42" Mini EX Brush Cutter 63cc Motor	2	6"	42"	1"	19-29	11,000-18,000
1BCEX48-63QC	48" Mini EX Brush Cutter 63cc Motor	3		48"			



- Blade Size: 6" wide x 11.94" long
- EX Blade Kit (Blade, Bolt, Lock Washer, and Nut (Nuts must be welded))



• 42" Excavator Cutter Blade Carrier



• 48" Excavator Cutter Blade Carrier

* Product design subject to change

FORESTRY MULCHER PIRAHNA SERIES



LAND CLEARING MACHINES, POWERFUL, AND VERSATILE ENOUGH TO CUT THROUGH OVERGROWN BRUSH, TREES, AND DENSE TERRAIN

For Mini / Compact Excavators

FORESTRY MULCHER

FOR MINI-EXCAVATORS 11,000-26,000 LBS

PIRAHNA SERIES



PRODUCT FEATURES:

- SINGLE SPEED DIRECT DRIVE MOTOR
- 15-50 GPM
- A/R WARE PLATES
- CASE DRAIN REQUIRED
- SIDE PANEL OFFERS ACCESSIBILITY TO HYDRAULICS
- 3 SECOND MOTOR RECOVERY TIME
- 30" CUTTING WIDTH
- QC OR PIN ON HITCH

Must Specify Host Machine at Time of Order)



- **Replacement Teeth & Parts Available for Order**

Item #	# of TEETH	Round	Square	Mulching Capacity Diameter	Tree Diameter	Excavator Weight	Oil Flow Required GPM	RPM	Est Weight With Mount (lbs)
1TMEX30 PO or QC	24	18	6	30"	8"	11-26k	15-50	3500 MAX	863

800.255.4461 • WWW.CONSTRUCTIONATTACHMENTS.COM • SALES@CALMFG.COM

DO NOT OPERATE MULCHER WITHOUT A SHATTERPROOF CAB DOOR ON LOADER.

**Specify make and model of host machine when ordering.
Prices and specifications subject to change without notice.**

18 Month Factory Warranty

DIGGING • HILL SCRAPING • TRENCHING • LOADING • BACK GRADING • EXCAVATING

**Specifically designed for increased machine performance
and long term durability**



EXCAVATOR BUCKET PRODUCT FEATURES:

- 1" beveled C1060 front cutting edge
- AR plate front side cutters, side plates and wear strips
- Integrated hitch backing plate and square top tube design add additional strength
- CAT style teeth
- Smooth edge also available
- Available widths: 12", 16", 18", 24", 30", 36" and 48"
- Available loader size (LBS): Kubota 040 (6-10k), Kubota 057 (11-15k), and Kubota 080 (16-20k)
- Quick attach or pin-on available



- Shown with select pin on mount

6-10K BUCKETS

- Available widths: 12" - 36"
- Product weight range: 158 - 380 lbs
- Shown with Kubota KX 040QC mount



11-15K BUCKETS

- Available widths: 12" - 48"
- Product weight range: 190 - 587 lbs
- Shown with Kubota KX 057QC mount

16-20K BUCKETS

- Available widths: 18" - 48"
- Product weight range: 472 - 1323 lbs
- Shown with Kubota KX 080QC mount



* Product design subject to change

DIGGING • HILL SCRAPING • TRENCHING • LOADING • BACK GRADING • EXCAVATING

**Specifically designed for increased machine performance
and long term durability**

KUBOTA STYLE COUPLER

PRODUCT FEATURES:

- Turn your pin on excavators into a quick attach
- Available loader sizes: 6-10k, 11-15k, 16-20k

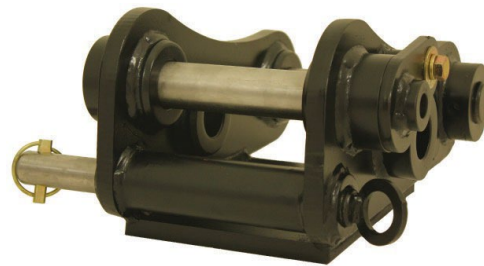

HYDRAULIC THUMB

PRODUCT FEATURES:

- Enhanced durability and operator accuracy during clamping
- Constructed of AR plate material
- Integral design increases surface area when clamping
- Larger diameter cylinder rod for increased clamping force
- Ridged / radical tooth design for aggressive applications
- Available in hydraulic only
- Available loader sizes: 6-10k, 11-15k, 16-20k



* Product design subject to change

EXCAVATOR BUCKETS-COUPPLERS-THUMBS



DIGGING • HILL SCRAPING • TRENCHING • LOADING • BACK GRADING • EXCAVATING

**Specifically designed for increased machine performance
and long term durability**

EXCAVATOR BUCKET PRODUCT FEATURES:

- 1" beveled C1060 front cutting edge
- AR plate front side cutters, side plates and wear strips
- Integrated hitch backing plate and square top tube design add additional strength
- CAT style teeth
- Smooth edge also available
- Available widths: 12", 16", 18", 24", 30", and 36"
- Available loader sizes: JD35G, JD50G, JD60G (also fits Hitachi)
- Wedge lock style mount available
- Forged D-Ring comes standard

JD 35G BUCKETS

- Available widths: 12"- 36"
- Product weight range: 158 - 380 lbs
- Shown with John Deere 35G mount



JD 50G BUCKETS

- Available widths: 12"- 36"
- Product weight range: 190 - 492 lbs
- Shown with John Deere 50G mount



JD 60G BUCKETS

- Available widths: 12"- 36"
- Product weight range: 190- 492 lbs
- Shown with John Deere 60G mount



* Product design subject to change

DESIGN ALLOWS THE USE OF MOST SKID STEER ATTACHMENTS TO ADAPT TO MINI EXCAVATORS



©2016 CONSTRUCTION ATTACHMENTS, INC. — WWW.CONSTRUCTIONATTACHMENTS.COM



SKID STEER ADAPTER “THE HOOKUP”

- Skid steer universal adapter for excavators
- For excavators up to 20,000 lbs
- Product weight: 264 lbs



The Hookup host hitch can be unbolted from the skid steer attachment, rotated 180 degrees, allowing the attachment to be used for:

- | | |
|-----------------|--------------|
| ✓ Back grading | ✓ Digging |
| ✓ Back hauling | ✓ Trenching |
| ✓ Back filling | ✓ Loading |
| ✓ Hill scraping | ✓ Excavating |

SKID ADAPTER PRODUCT FEATURES:

- Incorporates standard 2 pin universal skid steer latching system
- Mount in reversible for working toward and away from the host machine
- Shipped fully assembled and ready to work

* Product design subject to change

GENERAL PURPOSE BUCKETS



DIGGING • LEVELING • LOADING • GRADING • CARRYING • DUMPING

GENERAL-PURPOSE BUCKET ATTACHMENT OPTIONS:

- reversible bolt-on cutting edge
- bolt-on teeth
- bolt-on large teeth
- weld-on teeth
- bolt-on tooth bar
- bolt-on extended tooth bar



MINI SKID STEER STANDARD BOTTOM

- Available widths: 36", 42", 48", 54"
- Product weight range: 160 - 263 lbs



MINI SKID STEER HIGH CAPACITY

- Available widths: 36", 42", 48", 54"
- Product weight range: 263 - 386 lbs



COMPACT GENERAL PURPOSE

- Available widths: 54", 60", 66", 72"
- Product weight range: 156 - 356 lbs



XIREME DUTY EXTENDED BOTTOM LOW PROFILE

- Available widths: 62", 66", 72", 78", 84"
- Product weight range: 477 - 972 lbs

* Product design subject to change

GENERAL PURPOSE BUCKETS



DIGGING • LEVELING • LOADING • GRADING • CARRYING • DUMPING

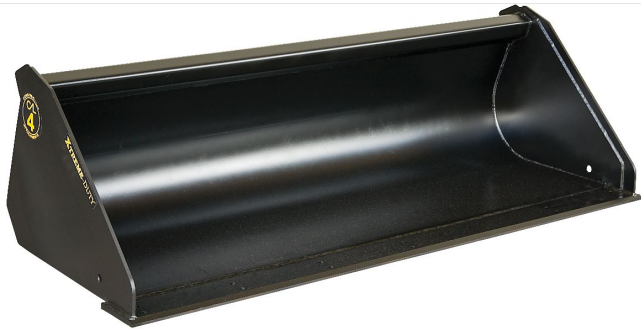

XTREME DUTY STANDARD BOTTOM LOW PROFILE

- Available widths: 62", 66", 72", 78", 84"
- Product weight range: 434 - 896 lbs



XTREME DUTY HIGH CAPACITY SCRAP

- Available widths: 66", 72", 78", 84"
- Product weight range: 512 - 704 lbs



XTREME DUTY HIGH CAPACITY / LIGHT MATERIAL

- Available widths: 66", 72", 78", 84"
- Product weight range: 523 - 756 lbs
- Shown with optional bolt-on edge



ULTRA DUTY LOW PROFILE

- Available widths: 73", 78", 84"
- Product weight range: 949 - 1228 lbs
- Bolt-on side cutters come standard



SEVERE XTREME DUTY LOW PROFILE

- Available widths: 67", 73", 78", 84", 88"
- Product weight range: 676 - 1036 lbs



XTREME DUTY NURSERY

- Available widths: 73"
- 4" x 1/2" solid edge material
- Removeable light weight top guard
- Product weight range: 563 lbs

* Product design subject to change

GENERAL PURPOSE BUCKETS



DIGGING • LEVELING • LOADING • GRADING • CARRYING • DUMPING



XTREME DUTY AGRICULTURAL STANDARD BACK

- Available widths: 74", 84", 93"
- Product weight range: 494 - 600 lbs



SEVERE XTREME DUTY AGRICULTURAL STANDARD BACK

- Available widths: 74", 84", 93"
- Product weight range: 592 - 863 lbs



XTREME DUTY AGRICULTURAL HIGH CAPACITY LITTER

- Available widths: 74", 84", 93"
- Product weight range: 786 - 946 lbs
- Optional rub rail available; see Parts and Accessories



INDUSTRIAL TRACTOR LOADER BACKHOE

- Available widths: 84", 88", 93"
- Product weight range: 919 - 1083 lbs



ULTRA DEEP HIGH CAPACITY LANDSCAPE

- Available widths: 74", 84", 93"
- Product weight range: 2188 - 2660 lbs

* Product design subject to change

4-IN-1 MULTI-PURPOSE BUCKETS



SCRAPING • BOTTOM DUMPING • CLAMPING • DIGGING • BULL DOZING • CLAM LOADING • BACK FILLING

STANDARD FEATURES INCLUDE:

- Reversible bolt-on dozer edge (excludes the mini 4in1 bucket)
- Radius moldboard for improved material loading and unloading
- Pre-drilled high carbon steel (C1064) front cutting edge to accommodate all bolt-on options

MULTI-PURPOSE BUCKET

ATTACHMENT OPTIONS

Our buckets include product specific options:

- reversible bolt-on cutting edge
- bolt-on teeth
- bolt-on large teeth
- weld-on teeth
- bolt-on tooth bar
- bolt-on extended tooth bar



MINI EXTENDED BOTTOM

- Available widths: 42", 48", 54"
- Product weight range: 416- 553 lbs



XTREME DUTY LOW CAPACITY

- Available widths: 60", 67", 73"
- Product weight range: 674 - 854 lbs
- Optional spill-guard available for additional capacity



COMPACT STANDARD BOTTOM

- Available widths: 54", 60", 66", 72"
- Product weight range: 430 - 625 lbs

* Product design subject to change

4-IN-1 MULTI-PURPOSE BUCKETS



SCRAPING • BOTTOM DUMPING • CLAMPING • DIGGING • BULL DOZING • CLAM LOADING • BACK FILLING



XTREME DUTY LOW PROFILE

- Available widths: 67", 73", 76"
- Product weight range: 884 - 1152 lbs



XTREME DUTY HIGH CAPACITY

- Available widths: 67", 73", 76"
- Product weight range: 858 - 1142 lbs



SEVERE XTREME DUTY LOW PROFILE

- Available widths: 67", 73", 76", 80", 84"
- Product weight range: 1018 - 1398 lbs
- Shown with optional bolt-on edge and bolt-on side cutters



SEVERE XTREME DUTY EXTENDED BOTTOM

- Available widths: 67", 73", 76", 80", 84"
- Product weight range: 1112 - 1384 lbs
- Available with bolt-on side cutters

* Product design subject to change

4-IN-1 MULTI-PURPOSE BUCKETS



SCRAPING • BOTTOM DUMPING • CLAMPING • DIGGING • BULL DOZING • CLAM LOADING • BACK FILLING



SEVERE XTREME DUTY HIGH CAPACITY

- Available widths: 80", 84"
- Product weight range: 989 - 1322 lbs
- Shown with optional bolt-on edge and bolt-on side cutters



ULTRA DUTY LOW PROFILE

- Available widths: 73", 76", 80", 84"
- Product weight range: 1308 - 1653 lbs
- Bolt-on side cutters come standard

1 YARD 4N1 BUCKET

-84"



INDUSTRIAL TRACTOR LOADER BACKHOE

- Available widths: 88", 93"
- Product weight range: 1288 - 1496 lbs
- Shown with optional bolt-on teeth

INDUSTRIAL TRACTOR LOADER BACKHOE

shown with optional swing over pallet forks



* Product design subject to change

GRAPPLES



HANDLING LOOSE MATERIAL • SORTING DEBRIS • DEMOLITION SITE CLEAN-UP • LAND CLEARING



MINI ROOT GRAPPLE

- Available widths: 36", 42", 48", 54"
- Product weight range: 195 - 275 lbs
- 48" and 54" models are available with dual lid design (36" and 42" models come standard with single lid design)



COMPACT ROOT GRAPPLE

- Available widths: 54", 60", 66", 72"
- Product weight range: 444 - 582 lbs



WORX DUTY ROOT GRAPPLE

- Available widths: 66", 73", 78", 84"
- Product weight range: 794 - 946 lbs



XTREME DUTY ROOT GRAPPLE

- Available widths: 66", 73", 78", 84"
- Product weight range: 990 - 1142 lbs



SEVERE XTREME DUTY ROOT GRAPPLE

- Available widths: 66", 73", 78", 84"
- Product weight range: 1140 - 1292 lbs
- Designed for high repetition duty cycles

* Product design subject to change

GRAPPLES



HANDLING LOOSE MATERIAL • SORTING DEBRIS • DEMOLITION SITE CLEAN-UP • LAND CLEARING



MINI GRAPPLE BUCKET

- Available widths: 36", 42", 48", 54"
- Product weight range: 246 - 312 lbs
- 48" and 54" models are available with dual lid design (36" and 42" models come standard with single lid design)



COMPACT GRAPPLE BUCKET

- Available widths: 54", 60", 66", 72"
- Product weight range: 566 - 764 lbs



XTREME DUTY GRAPPLE BUCKET

- Available widths: 60", 67", 73", 82"
- Product weight range: 962 - 1390 lbs
- High carbon steel (C1084) bolt-on reversible front cutting edge standard



WORX DUTY GRAPPLE BUCKET

- Available widths: 60", 67", 73", 82"
- Product weight range: 915 - 1090 lbs
- High carbon steel (C1084) bolt-on reversible front cutting edge standard

SEVERE XTREME DUTY GRAPPLE BUCKET

- Available widths: 60", 67", 73", 82"
- Product weight range: 1112 - 1540 lb
- High carbon steel (C1084) bolt-on reversible front cutting edge standard

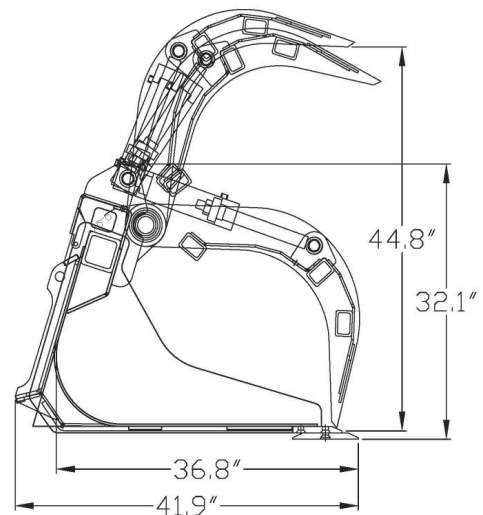

* Product design subject to change

HANDLING LOOSE MATERIAL • SORTING DEBRIS • DEMOLITION SITE CLEAN-UP • LAND CLEARING



COMPACT ROOT RAKE WITH GRAPPLE

- Available widths: 60", 66", 72"
- Product weight range: 470- 576 lbs
- Also available without Grapple; see Specialty Attachments



XTREME ROOT RAKE WITH GRAPPLE

- Available widths: 74", 80", 86"
- Product weight range: 1172- 1288 lbs
- Also available without Grapple; see Specialty Attachments



MINI SKELETON GRAPPLE

- Available widths: 36", 48", 56"
- Product weight range: 216 - 336 lbs
- Also available without Grapple; see Specialty Attachments



XTREME DUTY SKELETON GRAPPLE

- Available widths: 66", 73", 82"
- Product weight range: 900 -1092 lbs
- Also available without Grapple; see Specialty Attachments



SEVERE XTREME DUTY STUMP GRAPPLE BUCKET

- 55" plus grapple opening
- Product weight range: 1008 lbs
- Also available without Grapple; see Specialty Attachments

* Product design subject to change

PALLET FORKS



LIFTING • CARRYING

COMPACT

- Fork lift capacity: 2,200 lbs
- Available fork length: 42"



WORX DUTY

- Fork lift capacity: 4,200 lbs
- Available fork length: 42", 48"
- Skid steer universal hitch only
- Optional custom name cutout



XTREME DUTY STANDARD FRAME

For Skid Steer Universal Hitch

- Fork lift capacity: 4,200, 5,500, *6,400 lbs
- Available fork length: 42", 48", 60", 72", *96"
- Frame width: 45-1/2"



* Product design subject to change

PALLET FORKS



LIFTING • CARRYING



XTREME DUTY WIDE FRAME

For Skid Steer Universal Hitch

- Fork lift capacity: 4,200, 5,500, *6,400 lbs
- Available fork length: 42", 48", 60", 72", *96"
- Frame width: 57"



XTREME DUTY STANDARD FRAME

For AG Style Hitch

- Fork lift capacity: 4,200, 5,500, *6,400 lbs
- Available fork length: 42", 48", 60", 72", *96"
- Frame width: 45-1/2"

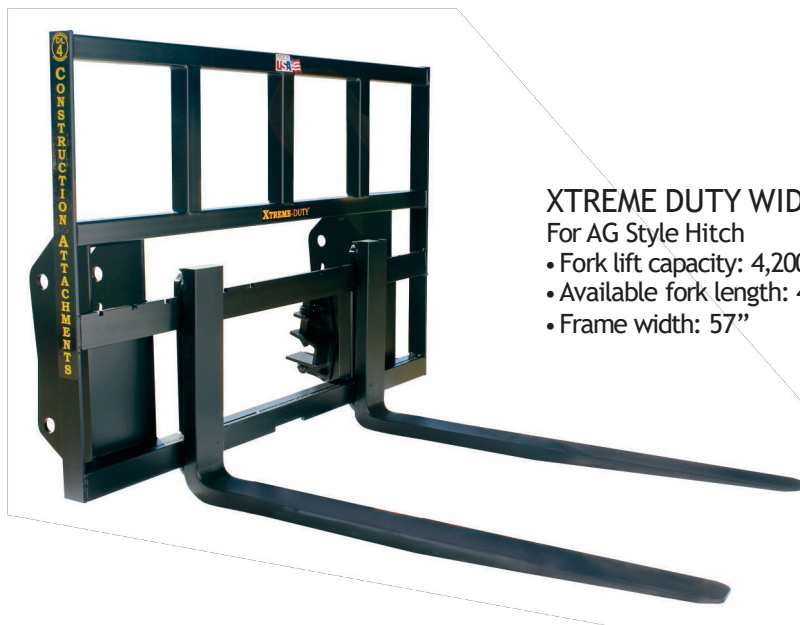

XTREME DUTY WIDE FRAME

For AG Style Hitch

- Fork lift capacity: 4,200, 5,500, *6,400 lbs
- Available fork length: 42", 48", 60", 72", *96"
- Frame width: 57"

* Product design subject to change

PALLET FORKS



LIFTING • CARRYING



XTREME DUTY WALK-THROUGH

- Fork lift capacity: 4,200, 5,500, *6,400 lbs
- Available fork length: 42", 48", 60", 72", *96"
- 14" opening for easy machine access



XTREME DUTY SHAFT MOUNT

- Fork lift capacity: 4,200 -5,500 lbs
- Available fork length: 48"
- 1-3/4" diameter shaft
- Ball fork sleeves available
(see Specialty Attachments section)



XTREME DUTY HYDRAULIC

- Fork lift capacity: 5,500 lbs
- Available fork length: 48"
- Dual fork carrier shaft's
- Ball fork sleeves available
(see Specialty Attachments section)

* Product design subject to change

PALLET FORKS



LIFTING • CARRYING



XTREME DUTY THREE POINT HITCH

- Fork lift capacity: 4,200 lbs
- Available fork length: 48"
- Fixed 22" spaced forks equipped with category 1 lower pins



INDUSTRIAL DUTY

- Fork Capacity: 5,500 - 6,400 lbs
- Available fork length: 42", 48"



XTREME DUTY SWING OVER FORK ASSEMBLY

Pallet forks shown installed on bucket; bucket not included

- Fork lift capacity: 5,500 lbs
- Available fork length: 42"
- Forks mount on bucket for quick use then fold over and latch for storage

* Product design subject to change

SPECIALTY ATTACHMENTS



NURSERIES • FARMS • FORESTRY • LANDSCAPING • CONSTRUCTION • SNOW AND ICE



XTREME DUTY SINGLE BALE SPEAR

- Rated spear capacity: 3,500 lbs @ 23" from collar
- 43.5" usable spear length



XTREME DUTY WIDE FRAME SINGLE BALE SPEAR

- Rated spear capacity: 3,500 lbs @ 23" from collar
- 43.5" usable spear length



XTREME DUTY DUAL BALE SPEAR

- Rated spear capacity: 3,500 lbs @ 23" from collar
- Usable spear length 43.5"
- 30" spacing between spears



XTREME DUTY WIDE FRAME DUAL BALE SPEAR

- Rated spear capacity: 3,500 lbs @ 23" from collar
- 43.5" usable spear length
- 30" spacing between spears

* Product design subject to change

SPECIALTY ATTACHMENTS



NURSERIES • FARMS • FORESTRY • LANDSCAPING • CONSTRUCTION • SNOW AND ICE

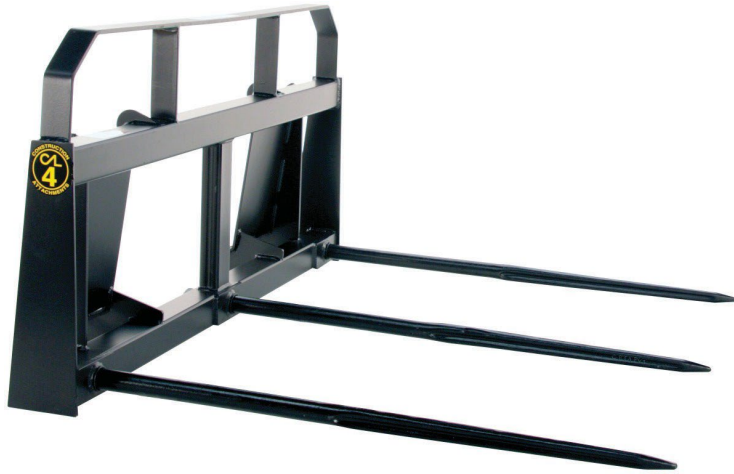

XTREME DUTY WIDE FRAME TRIPLE BALE SPEAR

- Rated spear capacity: 3,500 lbs @ 23" from collar
- Usable spear length 43.5"
- 23.25" spacing between spears



XTREME DUTY WIDE FRAME QUADRUPLE BALE SPEAR

- Rated spear capacity: 3,500 lbs @ 23" from collar
- Usable spear length 43.5"
- 30" spacing between spears



XTREME DUTY ULTRA WIDE FRAME DOUBLE SINGLE BALE SPEAR

- Rated spear capacity: 3,500 lbs @ 23" from collar
- Usable spear length 43.5"
- 60" spacing between spears

* Product design subject to change

SPECIALTY ATTACHMENTS



NURSERIES • FARMS • FORESTRY • LANDSCAPING • CONSTRUCTION • SNOW AND ICE



XTREME DUTY BOOM POLE
Available with open hook or closed lug design
• Also available in wide frame
• Rated lifting capacity: 1,500 lbs



XTREME DUTY TREE BOOM
• Adds 62" to lifting height of the machine
• Rate lifting capacity: 1,800 lbs



XTREME DUTY REAR STABILIZER
• Provides additional stability to the rear of skid steer loaders



XTREME DUTY TRAILER RELOCATOR
• Maximum gross towing weight of 10,000 lbs
• 2" square receiver tube
• Product weight: 180 lbs

XTREME DUTY RIPPER

- Rip Stumps and roots on Mini-Excavators
- Product weight: 168 LBS



XTREME DUTY BALL FORK SLEEVES

- Shown on pallet frame; pallet frame not included
- Designed to work with standard class II forks
 - Used for transporting nursery stock



* Product design subject to change

SPECIALTY ATTACHMENTS



NURSERIES • FARMS • FORESTRY • LANDSCAPING • CONSTRUCTION • SNOW AND ICE



WORX DUTY STUMP BUCKET

- Standard 3/4" x 6" cutting Edge with three weld-on teeth
- 400 lbs



XTREME DUTY STUMP BUCKET

- Standard 3/4" x 6" cutting edge with three weld-on teeth
- 578 lbs



MINI SKELETON BUCKET

- Available widths: 36", 48", 56"
- Product weight range: 163- 254 lbs



XTREME DUTY SKELETON BUCKET

- Available widths: 66", 73", 82"
- 2-7/16" tine spacing for screening
- Product weight range: 568 - 694 lbs



COMPACT ROOT RAKE

- Available widths: 60", 66", 72"
- Product weight range 250- 299 lbs



XTREME DUTY ROOT RAKE

- Available widths: 74", 80", 86"
- Product weight range: 634 - 740 bs

* Product design subject to change

SPECIALTY ATTACHMENTS



NURSERIES • FARMS • FORESTRY • LANDSCAPING • CONSTRUCTION • SNOW AND ICE



MINI SNOW BLADE

- Available widths: 36", 48", 54"
- Product weight range: 158 - 274 lbs
- Available in manual or hydraulic angle operation

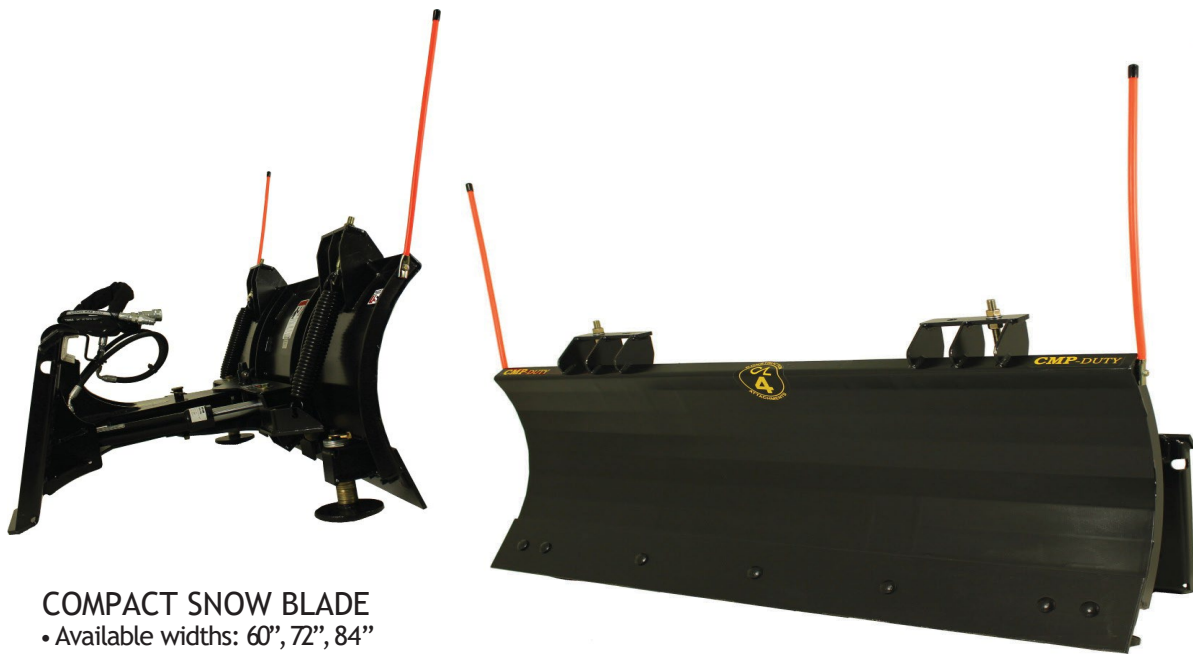

COMPACT SNOW BLADE

- Available widths: 60", 72", 84"
- Product weight range: 382 - 532 lbs
- Available in manual or hydraulic angle operation

* Product design subject to change

SPECIALTY ATTACHMENTS



NURSERIES • FARMS • FORESTRY • LANDSCAPING • CONSTRUCTION • SNOW AND ICE

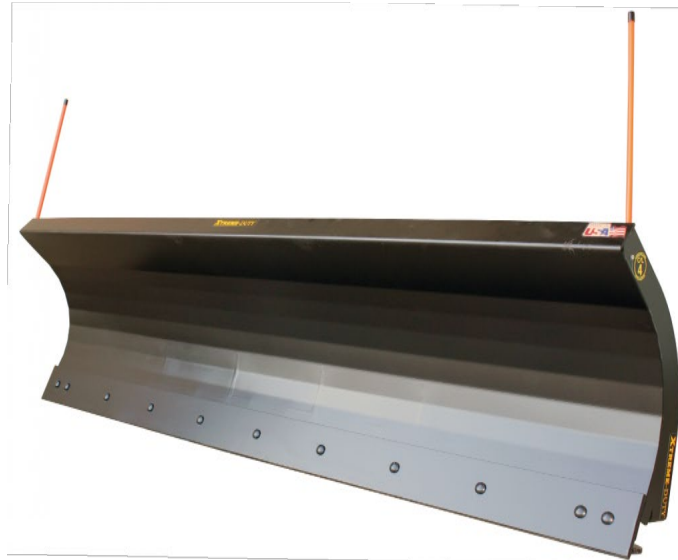

XTREME DUTY SNOW BLADE

- Available widths: 84", 93", 108"
- Product weight range: 738 - 1225 lbs
- Available in manual or hydraulic angle operation



MINI LAND LEVELER

- Available widths: 42", 48", 54"
- For mini skid steers
- Product weight range: 220 - 266 lbs

* Product design subject to change

TOOTH BARS



COMPACT DUTY BOLT-ON TOOTH BAR

- Available widths: 30" - 75"
- Designed to accommodate compact tractor buckets up to 1/2" thick front edge
- Equipped with case 2A tooth



XTREME DUTY BOLT-ON TOOTH BAR

- Available widths: 48" - 85"
- Designed to accommodate 3/4" weld-on edges
- Equipped with 23 series tooth



XTREME DUTY BOLT-ON EXTENDED TOOTH BAR

- Available widths: 48" - 85"
- Designed to accommodate both weld-on and bolt-on edges, combined thickness of 1-1/2"
- Equipped with 23 series tooth

BOLT-ON EDGES



BOLT-ON REVERSIBLE CUTTING EDGES

- Designed to work with Construction Attachments general purpose, multi-purpose, and grapple buckets
- Adds protection and longevity to your original front edge

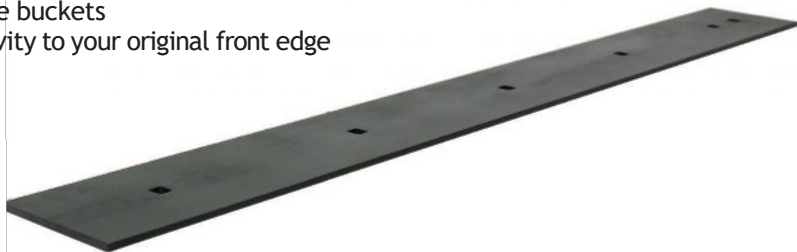

BOLT-ON REVERSIBLE SNOW BLADE EDGES

- Designed to work with Construction Attachments snow blades
- Available in rubber or steel

* Product design subject to change

BOLT-ON TEETH



REGULAR BOLT-ON TEETH

- Designed to work with Construction Attachments general purpose, and multi-purpose buckets
- Necessary when loosening compacted soil, digging, or excavating

LARGE BOLT-ON TEETH

- Designed to work with Construction Attachments general purpose, and multi-purpose buckets
- Necessary when loosening compacted soil, digging, or excavating

HITCH PLATES

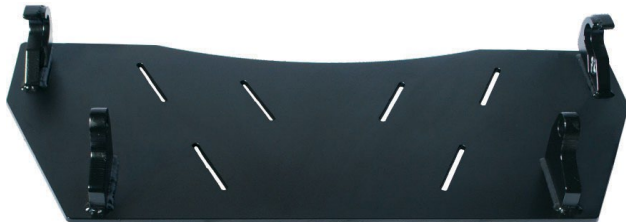

EURO STYLE - DELUXE SOLID HITCH PLATE ASSEMBLY

- Single plate design, pre-located hooks
- 3/8" plate backing material



UNIVERSAL STYLE - BLANK HITCH PLATE ASSEMBLY

- Constructed of two independent hitch plates for reduced weight
- 3/8" plate material with a full length top rail

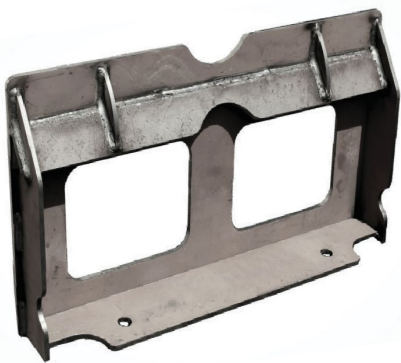

MINI UNIVERSAL - BLANK HITCH PLATE ASSEMBLY

- Designed for mini skid steer (Vermeer and Toro Dingo)
- 5/16" plate material with a full length 3/8" top rail



UNIVERSAL STYLE - DELUXE SOLID HITCH PLATE ASSEMBLY

- Designed for heavier applications
- 3/8" plate backing material

* Product design subject to change

ONE TOUCH KITS



D03 DIRECT FIT ONE TOUCH HYDRAULIC KIT

- For tractors with 14 gpm of auxiliary flow
- Kit pictured for a Kubota LA-524
- Sold with standard 2 button handle
- Optional 4 button handle
- Specify make and model of host machine



D05 DIRECT FIT ONE TOUCH HYDRAULIC KIT

- For tractors with 14.1 - 25 gpm of auxiliary flow
- Kit pictured for a Kubota 1353 Cab
- Sold with standard 2 button handle
- Optional 4 button handle
- Specify make and model of host machine



UNIVERSAL DIVERTER TYPE ONE TOUCH HYDRAULIC KIT

- For tractors with 20gpm of auxiliary flow
- Specify make and model of host machine
- Sold with standard 2 button handle
- Optional 4 button handle
- Specify make and model of host machine



D03 DIRECT FIT ONE TOUCH PARTIAL HYDRAULIC KIT

- For tractors with 14 gpm of auxiliary flow
- Partial kit does not include hoses
- Sold with standard 2 button handle
- Optional 4 button handle
- Specify make and model of host machine

* Product design subject to change



2 BUTTON ROCKER SWITCH HANDLE FOR DIRECT FIT ONE TOUCH HYDRAULIC KITS

- Optional
- Additional charge applies
- Specify make and model of host machine



4 BUTTON HANDLE FOR DIRECT FIT ONE TOUCH HYDRAULIC KITS

- Optional
- Additional charge applies
- Specify make and model of host machine

OTHER

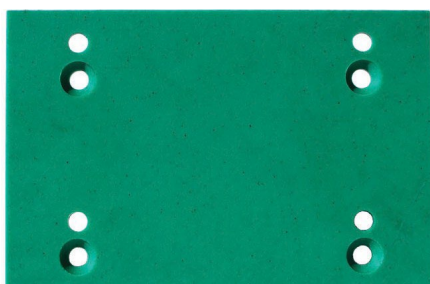

RUB RAILS

- Designed for use on Construction Attachments High Capacity Litter Buckets
- Made of 1/2" x 8" UHMW polyethylene plastic material



SNOW BLADE HYDRAULIC KIT

- Designed for use on Construction Attachments Mini, Compact and Xtreme Duty snow blades

CONSTRUCTION ATTACHMENTS, INC.®



Construction Attachments is a leading manufacturer of construction and agricultural grade attachments for tractors, compact excavators, skid steer loaders, tractor loader backhoes, and large excavators.

**“THE BITTERNESS OF POOR QUALITY LINGERS LONG AFTER
THE SWEETNESS OF A CHEAP PRICE IS FORGOTTEN!”**



1160 CAL COURT, LENOIR, NC 28645 USA
www.constructionattachments.com
sales@calmfg.com | ph (828) 758-2674 | fax (828) 754-1887

